



NEW PORTFOLIO OF SINK UNITS

with stainless steel
pressed tabletops



Made in Poland

See Stalgast
catalogs online

stalcast.eu





Table of Contents

Additional Services	3
Furniture Characteristics	5
Discover Benefits of New Tabletop Design & Construction	6
How to Select Sink Units	8
Dedicated 3D Design Tools	9
Key	10
Sink Units	11
1 - Single-Sink Units Without a Shelf	12
2 - Single-Sink Units With a Shelf	13
3 - Single-Sink Units, Hinged Doors	14
4 - Single-Sink Units, Sliding Doors	15
5 - Single-Sink Units With a Cabinet and a Shelf	16
6 - Single-Sink Units With a Block of Two Drawers and a Shelf	17
7 - Single-Sink Units With Space for a Refrigerator or a Dishwasher	18
8 - Double-Sink Units Without a Shelf	19
9 - Double-Sink Units With a Shelf	20
10 - Double-Sink Units, Hinged Doors	21
11 - Double-Sink Units, Sliding Doors	22
12 - Double-Sink Units With a Cabinet and a Shelf	23
13 - Double-Sink Units With a Block of Two Drawers and a Shelf	24
14 - Double-Sink Units With a Block of Three Drawers and a Shelf	25
15 - Double-Sink Units With Space for a Refrigerator or a Dishwasher	25
Technical Drawings	27
Chef's Tables	29
Discover Benefits and Usage of Chef's Tables	30
1 - Single-Sink Worktables With a Shelf	32
2 - Double-Sink Worktables With a Shelf	32
Technical Drawings	34

Portfolio of Sink Units
Additional Services



40 mm side flat upstand

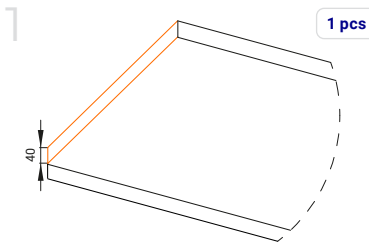

Net price: **31 €**

100x15 mm box-shaped upstand

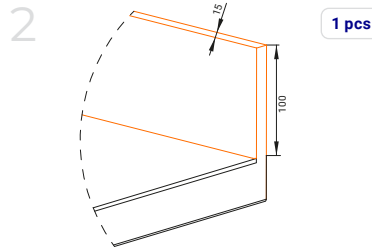

Net price: **57 €**

Drop nose

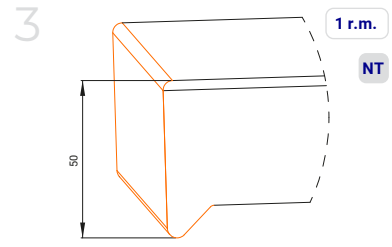

Net price: **32 €**

Additional legs

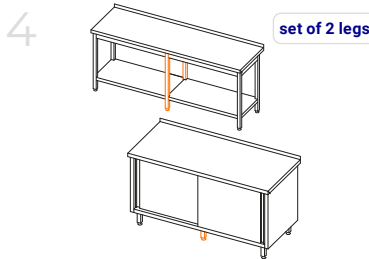

Net price: **32 €**

Sidewall cladding

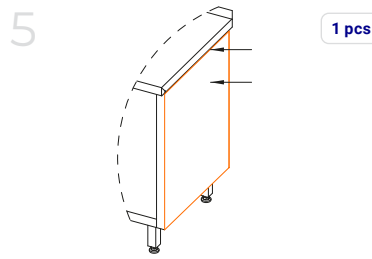

Net price: **39 €**

Back wall cladding

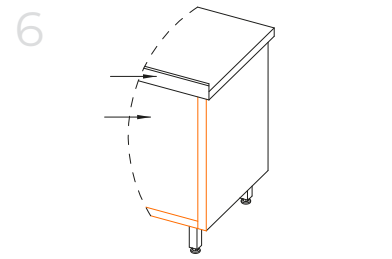

Net price: **72 €**

300 mm sink compartment cover

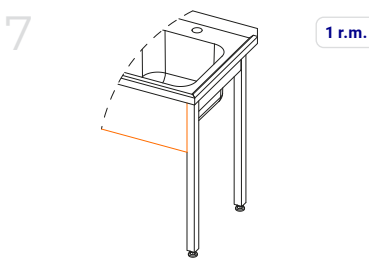

Net price: **60 €**

Shelf perforation

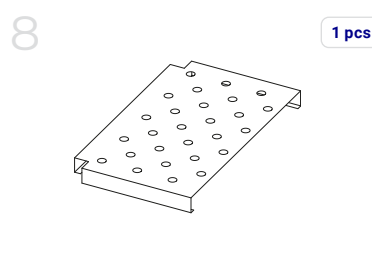

Net price: **32 €**

Additional drawer

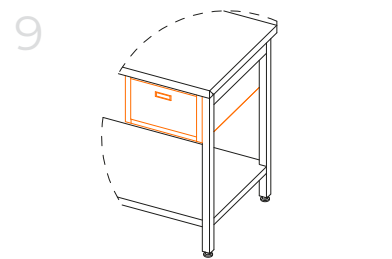

Net price: **167 €**

Hole for waste disposal unit

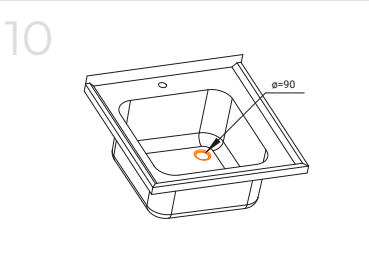

Net price: **32 €**

Door and drawer stainless steel handle

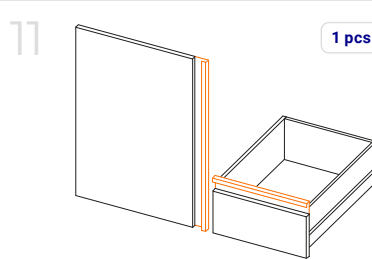

Net price: **32 €**

Additional shelf

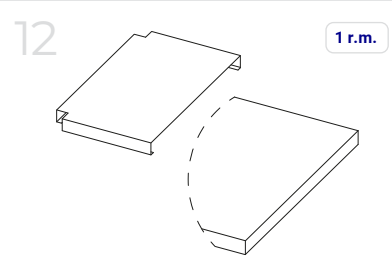

Net price: **88 €**



Portfolio of Sink Units

Additional Services

Hinged door
and drawer lock
(two keys included)

13

1 pcs

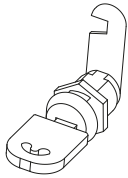

Net price: **39** €

Sliding door lock
(two keys included)

14

1 pcs

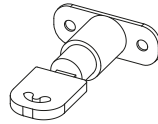

Net price: **39** €

Set of 4 100 mm castors
(including 2 with brake)

15

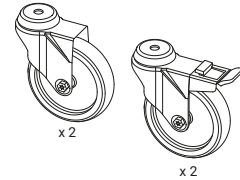

Net price: **159** €

Stainless steel adjustable
feet

16

1 pcs

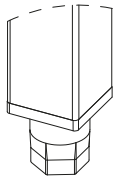

Net price: **12** €

150 mm plinth

17

1 r.m.

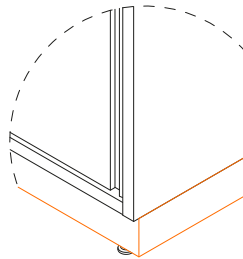

Net price: **54** €

NT

multiple services requested for a specific product require a separate quote from Stalgast

X pcs

price per "X" pieces

1 r.m.

price per running meter



please contact your sales representative to order this service



Depending on the product group, all our products are made from ferritic and/or austenitic steel. They are manufactured in monolithic welded, bonded, or bolted construction, appropriate for the product. All furniture is equipped with adjustable feet and a protective equipotential pin.

SPECIFICATIONS:



1. SINK UNITS

- pressed with a slope towards the sink compartment and a draining board (grooved or flat)
- lowered along the perimeter in relation to the top edge of the tabletop
- reinforced with bonded metal profiles (omega)
- unblinded hole for a 33 mm tap
- 40 mm flat rear upstand as standard



2. SINK COMPARTMENTS

- made of stainless steel
- fitted with a 52 mm siphon hole



3. UNIT LEGS

- made of 40x40 mm square profiles
- +25 mm to -5 mm adjustable feet



4. TABLE BASES

- reinforced with a metal frame or square profile in the upper part
- 150 mm clearance between the floor and the bottom edge of the profile, shelf, or furniture bottom



5. DOORS

- made of two layers of metal sheet in the form of a stiffened box
- fitted with a magnetic latch
- fitted with a recessed ABS handle



6. SLIDING DOORS

- with stainless steel internal guide and moved by rollers
- cradle at the bottom for easy disassembly of the doors
- recessed ABS handle



7. DRAWERS

- made of stainless steel
- guide rails made of galvanized steel, three sections, ball-bearings, full drawer extension
- toolless assembly and disassembly of cabinet body guides
- drawer front panel made of two layers of metal sheet in the form of a stiffened box
- maximum load up to 25 kg
- recessed ABS handle



Portfolio of Sink Units

Discover Benefits of New Tabletop Design & Construction

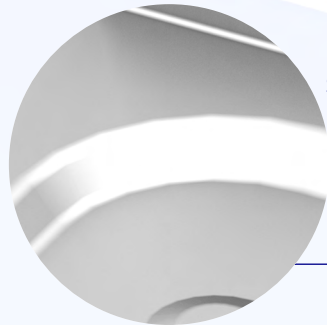

Uniform material structure of the tabletop with rounded inner edges of the recesses to facilitate cleaning.

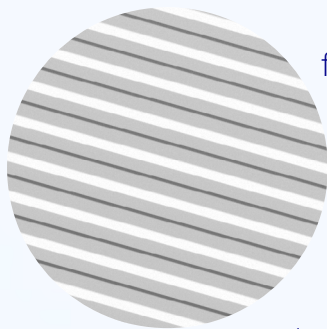

Pressed **grooved draining board for free water drainage** from under the products or items to be dried.

Rigid structure due to stamping technology and a grooved draining board.

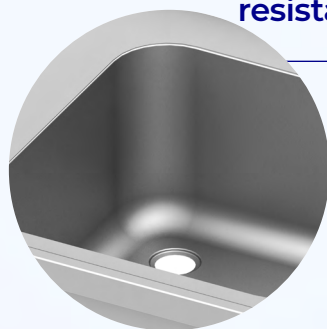

Tabletop and sink compartments **made of AISI 304 steel with high resistance** to corrosive agents.

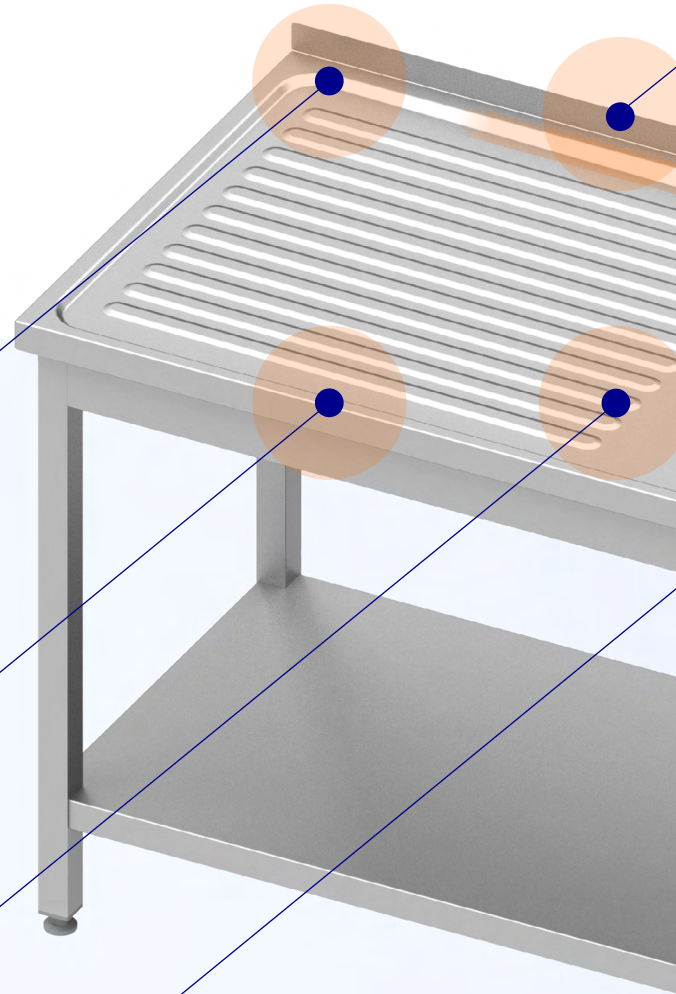

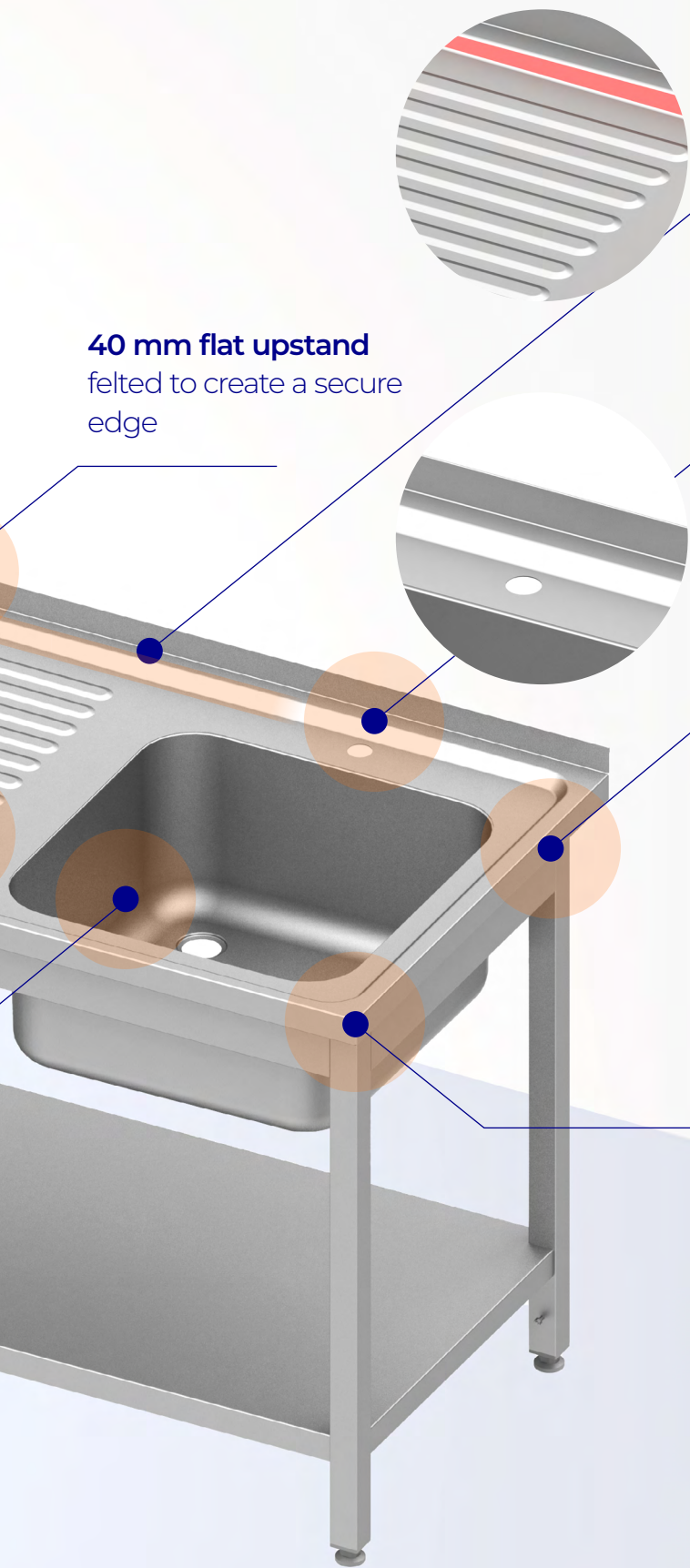

Directional, pressed slope for easy water drainage from the tabletop surface.

40 mm flat upstand
felted to create a secure edge

33 mm **hole for tap** ready to install sink tap available from Stalgast without additional construction changes.

Tabletop **reinforced with metal profiles (omega type)** bonded using an innovative technology without welding or visible welding points.

Welded corners

For design modifications, see the table of additional services on pages 3–4.



Portfolio of Sink Units

Tips: How to Select Sink Units

with pressed tabletops depending on process purposes

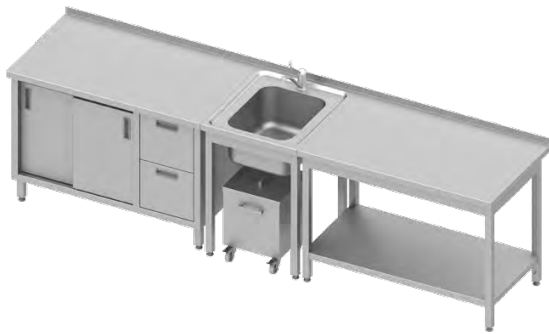

Single- or double-sink units with a pressed tabletop without a drip surface and with the minimum possible structural dimensions prove useful in functional arrangements where processes require only a maximum flat working surface, which can be obtained by adding an adjacent table with a flat work surface, e.g., to cut food or place tabletop equipment, rather than a drip surface.



See 3D model view

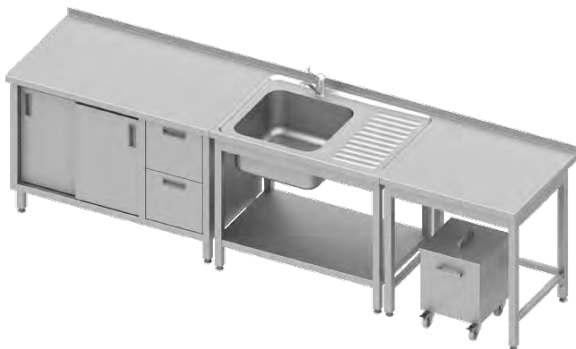

Single- or double-sink units with a pressed tabletop and a minimum drip surface width prove useful in functional arrangements where processes require an optimized draining surface with small amounts of products and a maximum flat working surface, which can be obtained by adding an adjacent table with a flat work surface, e.g., to cut food or place tabletop equipment.



See 3D model view

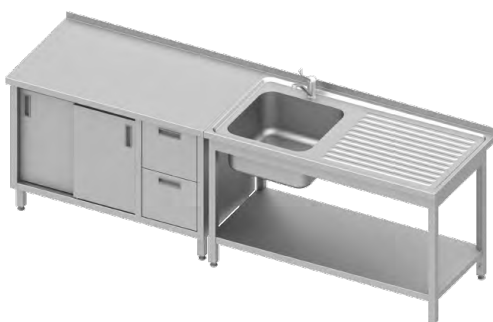

Wide single- or double-sink units with a pressed tabletop, characterized by a large draining surface, prove useful in functional arrangements where it is required to maximize the surface area to support technological processes with a large number of products and depending on the available design space, a flat work surface optimal for the processes.



See 3D model view

The portfolio of sink units with pressed tabletops includes a variety of under-tabletop constructions, such as frames with or without shelves, frames with cabinet and drawer modules, or cabinets with hinged or sliding doors. This allows for tailoring solutions for user needs based on process, functional, and ergonomic needs.

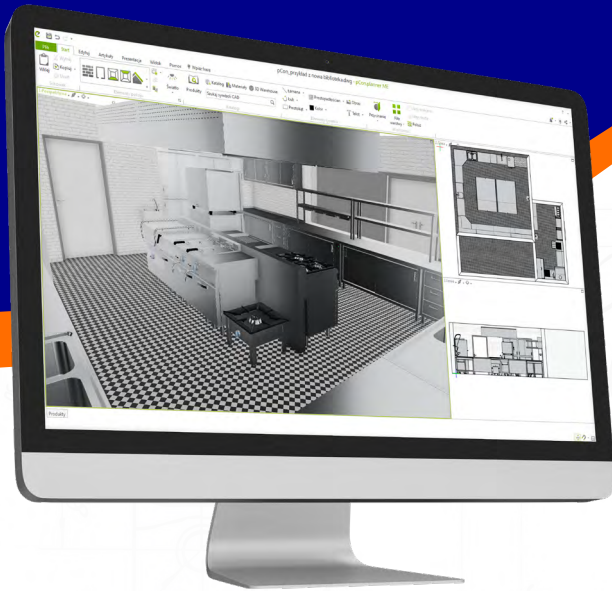

Discover the advantages of 3D design using Stalgast's product library, which includes a wide selection of our products. The updated library lets you see our product portfolio and implement complex projects with Stalgast professional equipment.



- streamline your offering and design processes
- simple and effective design
- create more accurate offers
- ensure better understanding of your solutions and faster decision-making by the customer
- eliminate the risk of mistakes during design changes by generating the current list of products directly from the software
- user friendly

See how to get dedicated access for our Business Partners.

Sign up for a free demo where we will share best practices and opportunities to use unique design tools.

**Sign up for
a demo**



Contact us for more details.



e-mail: [export@stalga**st**.com](mailto:export@stalgast.com)



Symbols used in the catalog

Key

Explanation of the product description

381

**SINGLE-SINK UNIT WITHOUT A SHELF
H=850 MM**

- recessed tabletop
- 40 mm flat upstand
- screw-joined table for self-assembly
- legs joined using bolts
- furniture shipped unassembled
- 33 mm tap hole in the middle of the compartment
- available tabletop depths (D): 600 mm or 700 mm
- 600 mm table fitted with a 400x400x250 mm compartment
- 700 mm table fitted with a 500x500x250 mm compartment

NEW

New product

W - Width
D - Depth
H - Height
∅ - Diameter

NS - New size

Number identifying a product subgroup

Product name

Product description

Product

Sink units

98 381 6 080

- identifies an assortment
- identifies a product subgroup – wall table with a shelf
- identifies furniture depth (D) – 600 mm
- identifies furniture width (W) – 400 mm

Width W (mm)	Depth D=600 (mm)		Depth D=700 (mm)	
	Cat. No.	Net Price (€)	Cat. No.	Net Price (€)
800	983816080	513	983817080	528
900	983816090	534	983817090	552
1000	983816100	548	983817100	574
...

NOTE!
A welded version of bolted furniture is available. Add the following letter to the catalog number: _____**S**,
e.g., **980046040S** – wall table with a shelf (400x600x850 mm **welded**).

Sink units



Portfolio of Sink Units

380

SINGLE-SINK UNIT WITHOUT A SHELF H=850 MM

- pressed tabletop
- 40 mm high flat upstand
- screw-joined table for self-assembly
- legs joined using bolts
- furniture shipped unassembled
- 33 mm tap hole
- available tabletop depths (D): 600 mm or 700 mm
- 600 mm table fitted with a 400x400x250 mm compartment
- 700 mm table fitted with a 500x500x250 mm compartment, except for 983137060 with a 400x500x250 mm compartment



Width W (mm)	Depth D=600 (mm)		Depth D=700 (mm)	
	Cat. No.	Net Price (€)	Cat. No.	Net Price (€)
600	983806060	472	983807060	487
700	-	-	983807070	511

381

SINGLE-SINK UNIT WITHOUT A SHELF H=850 MM

- pressed tabletop
- 40 mm flat upstand
- screw-joined table for self-assembly
- legs joined using bolts
- furniture shipped unassembled
- 33 mm tap hole
- available tabletop depths (D): 600 mm or 700 mm
- 600 mm table fitted with a 400x400x250 mm compartment
- 700 mm table fitted with a 500x500x250 mm compartment



Width W (mm)	Depth D=600 (mm)		
	Cat. No.	Net Price (€)	Width of grooved drainage R (mm)
800	983816080	513	-
900	983816090	534	-
1000	983816100	548	360
1100	983816110	572	360
1200	983816120	592	560
1300	983816130	613	560
1400	983816140	631	760

Width W (mm)	Depth D=700 (mm)		
	Cat. No.	Net Price (€)	Width of grooved drainage R (mm)
800	983817080	528	-
900	983817090	552	-
1000	983817100	574	260
1100	983817110	598	260
1200	983817120	616	460
1300	983817130	639	460
1400	983817140	663	660

382

SINGLE-SINK UNIT WITHOUT A SHELF H=850 MM

- pressed tabletop
- 40 mm flat upstand
- only welded
- 33 mm tap hole
- available tabletop depths (D): 600 mm or 700 mm
- 600 mm table fitted with a 400x400x250 mm compartment
- 700 mm table fitted with a 500x500x250 mm compartment

NEW



Width W (mm)	Depth D=600 (mm)		
	Cat. No.	Net Price (€)	Width of grooved drainage R (mm)
1500	983826150	654	760
1600	983826160	672	520
1700	983826170	693	520
1800	983826180	710	720
1900	983826190	735	720

Width W (mm)	Depth D=700 (mm)		
	Cat. No.	Net Price (€)	Width of grooved drainage R (mm)
1500	983827150	684	660
1600	983827160	707	320
1700	983827170	725	320
1800	983827180	747	520
1900	983827190	770	520

383

**SINGLE-SINK UNIT WITHOUT A SHELF
H=850 MM**

- pressed tabletop
- 40 mm flat upstand
- screw-joined table for self-assembly
- legs joined using bolts
- furniture shipped unassembled
- 33 mm tap hole
- available tabletop depths (D): 600 mm or 700 mm
- 600 mm table fitted with a 400x400x250 mm compartment
- 700 mm table fitted with a 500x500x250 mm compartment



Width W (mm)	Cat. No.	Depth D=600 (mm)	
		Net Price (€)	Width of grooved drainage R (mm)
800	983836080	513	-
900	983836090	534	-
1000	983836100	548	360
1100	983836110	572	360
1200	983836120	592	560
1300	983836130	613	560
1400	983836140	631	760

Width W (mm)	Cat. No.	Depth D=700 (mm)	
		Net Price (€)	Width of grooved drainage R (mm)
800	983837080	528	-
900	983837090	552	-
1000	983837100	574	260
1100	983837110	598	260
1200	983837120	616	460
1300	983837130	639	460
1400	983837140	663	660

384

**SINGLE-SINK UNIT WITHOUT A SHELF
H=850 MM**

- pressed tabletop
- 40 mm flat upstand
- only welded
- 33 mm tap hole
- available tabletop depths (D): 600 mm or 700 mm
- 600 mm table fitted with a 400x400x250 mm compartment
- 700 mm table fitted with a 500x500x250 mm compartment

NEW



Width W (mm)	Cat. No.	Depth D=600 (mm)	
		Net Price (€)	Width of grooved drainage R (mm)
1500	983846150	654	760
1600	983846160	672	520
1700	983846170	693	520
1800	983846180	710	720
1900	983846190	735	720

Width W (mm)	Cat. No.	Depth D=700 (mm)	
		Net Price (€)	Width of grooved drainage R (mm)
1500	983847150	684	660
1600	983847160	707	320
1700	983847170	725	320
1800	983847180	747	520
1900	983847190	770	520

313

**SINGLE-SINK UNIT WITH A SHELF
H=850 MM**

- pressed tabletop
- 40 mm flat upstand
- screw-joined table for self-assembly
- legs joined using bolts
- furniture shipped unassembled
- 33 mm tap hole
- available tabletop depths (D): 600 mm or 700 mm
- 600 mm table fitted with a 400x400x250 mm compartment
- 700 mm table fitted with a 500x500x250 mm compartment, except for 983137060 with a 400x500x250 mm compartment



Width W (mm)	Depth D=600 (mm)		Depth D=700 (mm)	
	Cat. No.	Net Price (€)	Cat. No.	Net Price (€)
600	983136060	505	983137060	522
700	-	-	983137070	548

Portfolio of Sink Units

314

SINGLE-SINK UNIT WITH A SHELF H=850 MM

- pressed tabletop
- 40 mm flat upstand
- screw-joined table for self-assembly
- legs joined using bolts
- furniture shipped unassembled
- 33 mm tap hole
- available tabletop depths (D): 600 mm or 700 mm
- 600 mm table fitted with a 400x400x250 mm compartment
- 700 mm table fitted with a 500x500x250 mm compartment



Width W (mm)	Cat. No.	Depth D=600 (mm)	
		Net Price (€)	Width of grooved drainage R (mm)
800	983146080	552	-
900	983146090	578	-
1000	983146100	604	360
1100	983146110	631	360
1200	983146120	651	560
1300	983146130	680	560
1400	983146140	706	760
1500	983146150	725	760
1600	983146160	750	520
1700	983146170	780	520
1800	983146180	803	720
1900	983146190	828	720

NS

Width W (mm)	Cat. No.	Depth D=700 (mm)	
		Net Price (€)	Width of grooved drainage R (mm)
800	983147080	584	-
900	983147090	610	-
1000	983147100	637	260
1100	983147110	666	260
1200	983147120	690	460
1300	983147130	718	460
1400	983147140	745	660
1500	983147150	770	660
1600	983147160	801	320
1700	983147170	825	320
1800	983147180	853	520
1900	983147190	879	520

NS

315

SINGLE-SINK UNIT WITH A SHELF H=850 MM

- pressed tabletop
- 40 mm flat upstand
- screw-joined table for self-assembly
- legs joined using bolts
- furniture shipped unassembled
- 33 mm tap hole
- available tabletop depths (D): 600 mm or 700 mm
- 600 mm table fitted with a 400x400x250 mm compartment
- 700 mm table fitted with a 500x500x250 mm compartment



Width W (mm)	Cat. No.	Depth D=600 (mm)	
		Net Price (€)	Width of grooved drainage R (mm)
800	983156080	552	-
900	983156090	578	-
1000	983156100	604	360
1100	983156110	631	360
1200	983156120	651	560
1300	983156130	680	560
1400	983156140	706	760
1500	983156150	725	760
1600	983156160	750	520
1700	983156170	780	520
1800	983156180	803	720
1900	983156190	828	720

NS

Width W (mm)	Cat. No.	Depth D=700 (mm)	
		Net Price (€)	Width of grooved drainage R (mm)
800	983157080	584	-
900	983157090	610	-
1000	983157100	637	260
1100	983157110	666	260
1200	983157120	690	460
1300	983157130	718	460
1400	983157140	745	660
1500	983157150	770	660
1600	983157160	801	320
1700	983157170	825	320
1800	983157180	853	520
1900	983157190	879	520

NS

385

SINGLE-SINK UNIT, HINGED DOORS H=850 MM

- pressed tabletop
- 40 mm flat upstand
- 33 mm tap hole
- available tabletop depths (D): 600 mm or 700 mm
- fitted with a 400x400x250 mm compartment
- door hinged on the left
- the cabinet has no back wall
- optional lock assembly for an additional net price: 39 € per piece



Width W (mm)	Depth D=600 (mm)		Depth D=700 (mm)	
	Cat. No.	Net Price (€)	Cat. No.	Net Price (€)
500	983856050	684	983857050	716
600	983856060	736	983857060	765

386

**SINGLE-SINK UNIT, HINGED DOORS
H=850 MM**

- pressed tabletop
- 40 mm flat upstand
- 33 mm tap hole
- available tabletop depths (D): 600 mm or 700 mm
- 600 mm table fitted with a 400x400x250 mm compartment
- 700 mm table fitted with a 500x500x250 mm compartment
- three wing doors in >1400 mm tables
- the cabinet has no back wall
- optional lock assembly for an additional net price: 39 € per piece



		Depth D=600 (mm)		
Width W (mm)	Cat. No.	Net Price (€)	Width of grooved drainage R (mm)	
800	983866080	818	-	
900	983866090	862	-	
1000	983866100	901	360	
1100	983866110	942	360	
1200	983866120	986	560	
1300	983866130	1024	560	
1400	983866140	1059	760	
1500	983866150	1097	760	
1600	983866160	1135	520	
1700	983866170	1173	520	
1800	983866180	1211	720	
1900	983866190	1249	720	

NS

		Depth D=700 (mm)		
Width W (mm)	Cat. No.	Net Price (€)	Width of grooved drainage R (mm)	
800	983867080	862	-	
900	983867090	903	-	
1000	983867100	942	260	
1100	983867110	988	260	
1200	983867120	1029	460	
1300	983867130	1071	460	
1400	983867140	1114	660	
1500	983867150	1152	660	
1600	983867160	1190	320	
1700	983867170	1228	320	
1800	983867180	1266	520	
1900	983867190	1304	520	

NS

387

**SINGLE-SINK UNIT, HINGED DOORS
H=850 MM**

- pressed tabletop
- 40 mm flat upstand
- 33 mm tap hole
- available tabletop depths (D): 600 mm or 700 mm
- 600 mm table fitted with a 400x400x250 mm compartment
- 700 mm table fitted with a 500x500x250 mm compartment
- three wing doors in >1400 mm tables
- the cabinet has no back wall
- optional lock assembly for an additional net price: 39 € per piece



		Depth D=600 (mm)		
Width W (mm)	Cat. No.	Net Price (€)	Width of grooved drainage R (mm)	
800	983876080	818	-	
900	983876090	862	-	
1000	983876100	901	360	
1100	983876110	942	360	
1200	983876120	986	560	
1300	983876130	1024	560	
1400	983876140	1059	760	
1500	983876150	1097	760	
1600	983876160	1135	520	
1700	983876170	1173	520	
1800	983876180	1211	720	
1900	983876190	1249	720	

NS

		Depth D=700 (mm)		
Width W (mm)	Cat. No.	Net Price (€)	Width of grooved drainage R (mm)	
800	983877080	862	-	
900	983877090	903	-	
1000	983877100	942	260	
1100	983877110	988	260	
1200	983877120	1029	460	
1300	983877130	1071	460	
1400	983877140	1114	660	
1500	983877150	1152	660	
1600	983877160	1190	320	
1700	983877170	1228	320	
1800	983877180	1266	520	
1900	983877190	1304	520	

NS

388

**SINGLE-SINK UNIT, SLIDING DOORS
H=850 MM**

- pressed tabletop
- 40 mm flat upstand
- 33 mm tap hole
- available tabletop depths (D): 600 mm or 700 mm
- 600 mm table fitted with a 400x400x250 mm compartment
- 700 mm table fitted with a 500x500x250 mm compartment
- the cabinet has no back wall
- optional lock assembly for an additional net price: 39 € per piece



		Depth D=600 (mm)		
Width W (mm)	Cat. No.	Net Price (€)	Width of grooved drainage R (mm)	
800	983886080	848	-	
900	983886090	880	-	
1000	983886100	909	360	
1100	983886110	942	360	
1200	983886120	974	560	
1300	983886130	1006	560	
1400	983886140	1035	760	
1500	983886150	1067	760	
1600	983886160	1097	520	
1700	983886170	1130	520	
1800	983886180	1159	720	
1900	983886190	1188	720	

NS

		Depth D=700 (mm)		
Width W (mm)	Cat. No.	Net Price (€)	Width of grooved drainage R (mm)	
800	983887080	897	-	
900	983887090	933	-	
1000	983887100	968	260	
1100	983887110	1000	260	
1200	983887120	1033	460	
1300	983887130	1068	460	
1400	983887140	1104	660	
1500	983887150	1133	660	
1600	983887160	1164	320	
1700	983887170	1200	320	
1800	983887180	1236	520	
1900	983887190	1269	520	

NS

389

**SINGLE-SINK UNIT, SLIDING DOORS
H=850 MM**

- pressed tabletop
- 40 mm flat upstand
- 33 mm tap hole
- available tabletop depths (D): 600 mm or 700 mm
- 600 mm table fitted with a 400x400x250 mm compartment
- 700 mm table fitted with a 500x500x250 mm compartment
- the cabinet has no back wall
- optional lock assembly for an additional net price: 39 € per piece



Depth D=600 (mm)			
Width W (mm)	Cat. No.	Net Price (€)	Width of grooved drainage R (mm)
800	983896080	848	-
900	983896090	880	-
1000	983896100	909	360
1100	983896110	942	360
1200	983896120	974	560
1300	983896130	1006	560
1400	983896140	1035	760
1500	983896150	1067	760
1600	983896160	1097	520
1700	983896170	1130	520
1800	983896180	1159	720
1900	983896190	1188	720

NS

Depth D=700 (mm)			
Width W (mm)	Cat. No.	Net Price (€)	Width of grooved drainage R (mm)
800	983897080	897	-
900	983897090	933	-
1000	983897100	968	260
1100	983897110	1000	260
1200	983897120	1033	460
1300	983897130	1068	460
1400	983897140	1104	660
1500	983897150	1133	660
1600	983897160	1164	320
1700	983897170	1200	320
1800	983897180	1236	520
1900	983897190	1269	520

NS

1090

**SINGLE-SINK UNIT WITH A CABINET AND A SHELF
H=850 MM**

- pressed tabletop
- 40 mm flat upstand
- adjustable shelf inside the cabinet
- 33 mm tap hole
- 600 mm table fitted with a 400x400x250 mm compartment
- 700 mm table fitted with a 500x500x250 mm compartment, except for 9810907100 with a 400x500x250 mm compartment
- waste shredder hole can be cut for an additional net price: 32 €
- optional lock assembly for an additional net price: 39 € per piece

NEW



Depth D=600 (mm)			
Width W (mm)	Cat. No.	Net Price (€)	Width of grooved drainage R (mm)
1000	9810906100	834	360
1100	9810906110	852	360
1200	9810906120	876	560
1300	9810906130	896	560
1400	9810906140	918	760
1500	9810906150	942	760
1600	9810906160	969	520
1700	9810906170	991	520
1800	9810906180	1014	720
1900	9810906190	1032	720

Depth D=700 (mm)			
Width W (mm)	Cat. No.	Net Price (€)	Width of grooved drainage R (mm)
1000	9810907100	876	260
1100	9810907110	896	260
1200	9810907120	921	460
1300	9810907130	948	460
1400	9810907140	973	660
1500	9810907150	996	660
1600	9810907160	1024	320
1700	9810907170	1044	320
1800	9810907180	1068	520
1900	9810907190	1097	520

1091

**SINGLE-SINK UNIT WITH A CABINET AND A SHELF
H=850 MM**

- pressed tabletop
- 40 mm flat upstand
- adjustable shelf inside the cabinet
- 33 mm tap hole
- 600 mm table fitted with a 400x400x250 mm compartment
- 700 mm table fitted with a 500x500x250 mm compartment, except for 9810917100 with a 400x500x250 mm compartment
- waste shredder hole can be cut for an additional net price: 32 €
- optional lock assembly for an additional net price: 39 € per piece

NEW



Depth D=600 (mm)			
Width W (mm)	Cat. No.	Net Price (€)	Width of grooved drainage R (mm)
1000	9810916100	834	360
1100	9810916110	852	360
1200	9810916120	876	560
1300	9810916130	896	560
1400	9810916140	918	760
1500	9810916150	942	760
1600	9810916160	969	520
1700	9810916170	991	520
1800	9810916180	1014	720
1900	9810916190	1032	720

Depth D=700 (mm)			
Width W (mm)	Cat. No.	Net Price (€)	Width of grooved drainage R (mm)
1000	9810917100	876	260
1100	9810917110	896	260
1200	9810917120	921	460
1300	9810917130	948	460
1400	9810917140	973	660
1500	9810917150	996	660
1600	9810917160	1024	320
1700	9810917170	1044	320
1800	9810917180	1068	520
1900	9810917190	1097	520

1072

**SINGLE-SINK UNIT WITH A BLOCK OF TWO DRAWERS AND A SHELF
H=850 MM**

- pressed tabletop
- 40 mm flat upstand
- 200 mm deep drawers
- 33 mm tap hole
- 600 mm table fitted with a 400x400x250 mm compartment
- 700 mm table fitted with a 500x500x250 mm compartment, except for 9810727100 with a 400x500x250 mm compartment
- waste shredder hole can be cut for an additional net price: 32 €
- optional lock assembly for an additional net price: 39 € per piece

NEW



Depth D=600 (mm)			
Width W (mm)	Cat. No.	Net Price (€)	Width of grooved drainage R (mm)
1000	9810726100	916	360
1100	9810726110	938	360
1200	9810726120	960	560
1300	9810726130	986	560
1400	9810726140	1004	760
1500	9810726150	1032	760
1600	9810726160	1050	520
1700	9810726170	1074	520
1800	9810726180	1097	720
1900	9810726190	1122	720

Depth D=700 (mm)			
Width W (mm)	Cat. No.	Net Price (€)	Width of grooved drainage R (mm)
1000	9810727100	973	260
1100	9810727110	996	260
1200	9810727120	1024	460
1300	9810727130	1046	460
1400	9810727140	1074	660
1500	9810727150	1097	660
1600	9810727160	1124	320
1700	9810727170	1142	320
1800	9810727180	1168	520
1900	9810727190	1190	520

1073

**SINGLE-SINK UNIT WITH A BLOCK OF TWO DRAWERS AND A SHELF
H=850 MM**

- pressed tabletop
- 40 mm flat upstand
- 200 mm deep drawers
- 33 mm tap hole
- 600 mm table fitted with a 400x400x250 mm compartment
- 700 mm table fitted with a 500x500x250 mm compartment, except for 9810737100 with a 400x500x250 mm compartment
- waste shredder hole can be cut for an additional net price: 32 €
- optional lock assembly for an additional net price: 39 € per piece

NEW



Depth D=600 (mm)			
Width W (mm)	Cat. No.	Net Price (€)	Width of grooved drainage R (mm)
1000	9810736100	916	360
1100	9810736110	938	360
1200	9810736120	960	560
1300	9810736130	986	560
1400	9810736140	1004	760
1500	9810736150	1032	760
1600	9810736160	1050	520
1700	9810736170	1074	520
1800	9810736180	1097	720
1900	9810736190	1122	720

Depth D=700 (mm)			
Width W (mm)	Cat. No.	Net Price (€)	Width of grooved drainage R (mm)
1000	9810737100	973	260
1100	9810737110	996	260
1200	9810737120	1024	460
1300	9810737130	1046	460
1400	9810737140	1074	660
1500	9810737150	1097	660
1600	9810737160	1124	320
1700	9810737170	1142	320
1800	9810737180	1168	520
1900	9810737190	1190	520

1074

**SINGLE-SINK UNIT WITH A BLOCK OF THREE DRAWERS AND A SHELF
H=850 MM**

- pressed tabletop
- 40 mm flat upstand
- 150 mm deep drawers
- 33 mm tap hole
- 600 mm table fitted with a 400x400x250 mm compartment
- 700 mm table fitted with a 500x500x250 mm compartment, except for 9810747100 with a 400x500x250 mm compartment
- waste shredder hole can be cut for an additional net price: 32 €
- optional lock assembly for an additional net price: 39 € per piece

NEW



Depth D=600 (mm)			
Width W (mm)	Cat. No.	Net Price (€)	Width of grooved drainage R (mm)
1000	9810746100	1215	360
1100	9810746110	1237	360
1200	9810746120	1266	560
1300	9810746130	1288	560
1400	9810746140	1315	760
1500	9810746150	1338	760
1600	9810746160	1361	520
1700	9810746170	1391	520
1800	9810746180	1413	720
1900	9810746190	1439	720

Depth D=700 (mm)			
Width W (mm)	Cat. No.	Net Price (€)	Width of grooved drainage R (mm)
1000	9810747100	1288	260
1100	9810747110	1315	260
1200	9810747120	1338	460
1300	9810747130	1371	460
1400	9810747140	1394	660
1500	9810747150	1427	660
1600	9810747160	1449	320
1700	9810747170	1472	320
1800	9810747180	1505	520
1900	9810747190	1530	520

1075

**SINGLE-SINK UNIT WITH A BLOCK OF THREE DRAWERS AND A SHELF
H=850 MM**

- pressed tabletop
- 40 mm flat upstand
- 150 mm deep drawers
- 33 mm tap hole
- 600 mm table fitted with a 400x400x250 mm compartment
- 700 mm table fitted with a 500x500x250 mm compartment, except for 9810757100 with a 400x500x250 mm compartment
- waste shredder hole can be cut for an additional net price: 32 €
- optional lock assembly for an additional net price: 39 € per piece



NEW

Depth D=600 (mm)			
Width W (mm)	Cat. No.	Net Price (€)	Width of grooved drainage R (mm)
1000	9810756100	1215	360
1100	9810756110	1237	360
1200	9810756120	1266	560
1300	9810756130	1288	560
1400	9810756140	1315	760
1500	9810756150	1338	760
1600	9810756160	1361	520
1700	9810756170	1391	520
1800	9810756180	1413	720
1900	9810756190	1439	720

Depth D=700 (mm)			
Width W (mm)	Cat. No.	Net Price (€)	Width of grooved drainage R (mm)
1000	9810757100	1288	260
1100	9810757110	1315	260
1200	9810757120	1338	460
1300	9810757130	1371	460
1400	9810757140	1394	660
1500	9810757150	1427	660
1600	9810757160	1449	320
1700	9810757170	1472	320
1800	9810757180	1505	520
1900	9810757190	1530	520

1060

**SINGLE-SINK UNIT WITH SPACE FOR A REFRIGERATOR OR A DISHWASHER
H=900 MM**

- pressed tabletop
- 40 mm flat upstand
- screw-joined table for self-assembly
- legs joined using bolts
- furniture shipped unassembled
- 33 mm tap hole
- 600 mm table fitted with a 400x400x250 mm compartment
- 700 mm table fitted with a 500x500x250 mm compartment, except for 9810607120 with a 400x500x250 mm compartment
- waste shredder hole can be cut for an additional net price: 32 €



NEW

Depth D=600 (mm)			
Width W (mm)	Cat. No.	Net Price (€)	Width of grooved drainage R (mm)
1200	9810606120	574	560
1300	9810606130	597	560
1400	9810606140	614	760
1500	9810606150	634	760
1600	9810606160	654	520
1700	9810606170	674	520
1800	9810606180	695	720
1900	9810606190	715	720

Depth D=700 (mm)			
Width W (mm)	Cat. No.	Net Price (€)	Width of grooved drainage R (mm)
1200	9810607120	599	460
1300	9810607130	624	460
1400	9810607140	644	660
1500	9810607150	670	660
1600	9810607160	687	320
1700	9810607170	710	320
1800	9810607180	727	520
1900	9810607190	750	520

1061

**SINGLE-SINK UNIT WITH SPACE FOR A REFRIGERATOR OR A DISHWASHER
H=900 MM**

- pressed tabletop
- 40 mm flat upstand
- screw-joined table for self-assembly
- legs joined using bolts
- furniture shipped unassembled
- 33 mm tap hole
- 600 mm table fitted with a 400x500x250 mm compartment
- 700 mm table fitted with a 500x500x250 mm compartment, except for 9810617120 with a 400x400x250 mm compartment
- waste shredder hole can be cut for an additional net price: 32 €



NEW

Depth D=600 (mm)			
Width W (mm)	Cat. No.	Net Price (€)	Width of grooved drainage R (mm)
1200	9810616120	574	560
1300	9810616130	597	560
1400	9810616140	614	760
1500	9810616150	634	760
1600	9810616160	654	520
1700	9810616170	674	520
1800	9810616180	695	720
1900	9810616190	715	720

Depth D=700 (mm)			
Width W (mm)	Cat. No.	Net Price (€)	Width of grooved drainage R (mm)
1200	9810617120	599	460
1300	9810617130	624	460
1400	9810617140	644	660
1500	9810617150	670	660
1600	9810617160	687	320
1700	9810617170	710	320
1800	9810617180	727	520
1900	9810617190	750	520

390

**DOUBLE-SINK UNIT WITHOUT A SHELF
H=850 MM**

- pressed tabletop
- 40 mm flat upstand
- screw-joined table for self-assembly
- legs joined using bolts
- furniture shipped unassembled
- centrally located compartments
- 33 mm tap hole between the compartments
- available tabletop depths (D): 600 mm or 700 mm
- 600 mm table fitted with 400x400x250 mm compartments
- 700 mm table fitted with 400x500x250 mm compartments



Width W (mm)	Depth D=600 (mm)		Depth D=700 (mm)	
	Cat. No.	Net Price (€)	Cat. No.	Net Price (€)
1000	983906100	666	983907100	686

391

**DOUBLE-SINK UNIT WITHOUT A SHELF
H=850 MM**

- pressed tabletop
- 40 mm flat upstand
- screw-joined table for self-assembly
- legs joined using bolts
- furniture shipped unassembled
- 33 mm tap hole between the compartments
- available tabletop depths (D): 600 mm or 700 mm
- 600 mm table fitted with 400x400x250 mm compartments
- 700 mm table fitted with 500x500x250 mm compartments, except for 983917110 with 400x500x250 mm compartments



Width W (mm)	Depth D=600 (mm)		
	Cat. No.	Net Price (€)	Width of grooved drainage R (mm)
1100	983916110	690	-
1200	983916120	710	-
1300	983916130	730	-
1400	983916140	748	320

Width W (mm)	Depth D=700 (mm)	
	Cat. No.	Net Price (€)
1100	983917110	716
1200	983917120	736
1300	983917130	754
1400	983917140	775

392

**DOUBLE-SINK UNIT WITHOUT A SHELF
H=850 MM**

- pressed tabletop
- 40 mm flat upstand
- only welded
- 33 mm tap hole between the compartments
- available tabletop depths (D): 600 mm or 700 mm
- 600 mm table fitted with 400x400x250 mm compartments
- 700 mm table fitted with 500x500x250 mm compartments

NEW



Width W (mm)	Depth D=600 (mm)		
	Cat. No.	Net Price (€)	Width of grooved drainage R (mm)
1500	983926150	768	320
1600	983926160	785	520
1700	983926170	805	520
1800	983926180	828	720
1900	983926190	847	720

Width W (mm)	Depth D=700 (mm)		
	Cat. No.	Net Price (€)	Width of grooved drainage R (mm)
1500	983927150	800	-
1600	983927160	823	320
1700	983927170	840	320
1800	983927180	863	520
1900	983927190	886	520

Portfolio of Sink Units

393

DOUBLE-SINK UNIT WITHOUT A SHELF H=850 MM

- pressed tabletop
- 40 mm flat upstand
- screw-joined table for self-assembly
- legs joined using bolts
- furniture shipped unassembled
- 33 mm tap hole between the compartments
- available tabletop depths (D): 600 mm or 700 mm
- 600 mm table fitted with 400x400x250 mm compartments
- 700 mm table fitted with 500x500x250 mm compartments, except for 983937110 with 400x500x250 mm compartments



Width W (mm)	Cat. No.	Depth D=600 (mm)	
		Net Price (€)	Width of grooved drainage R (mm)
1100	983936110	690	-
1200	983936120	710	-
1300	983936130	730	-
1400	983936140	748	320

Width W (mm)	Cat. No.	Depth D=700 (mm)	
		Net Price (€)	Width of grooved drainage R (mm)
1100	983937110	716	-
1200	983937120	736	-
1300	983937130	754	-
1400	983937140	775	-

394

DOUBLE-SINK UNIT WITHOUT A SHELF H=850 MM

- pressed tabletop
- 40 mm flat upstand
- only welded
- 33 mm tap hole between the compartments
- available tabletop depths (D): 600 mm or 700 mm
- 600 mm table fitted with 400x400x250 mm compartments
- 700 mm table fitted with 500x500x250 mm compartments

NEW



Width W (mm)	Cat. No.	Depth D=600 (mm)	
		Net Price (€)	Width of grooved drainage R (mm)
1500	983946150	768	320
1600	983946160	785	520
1700	983946170	805	520
1800	983946180	828	720
1900	983946190	847	720

Width W (mm)	Cat. No.	Depth D=700 (mm)	
		Net Price (€)	Width of grooved drainage R (mm)
1500	983947150	800	-
1600	983947160	823	320
1700	983947170	840	320
1800	983947180	863	520
1900	983947190	886	520

395

DOUBLE-SINK UNIT WITH A SHELF H=850 MM

- pressed tabletop
- 40 mm flat upstand
- screw-joined table for self-assembly
- legs joined using bolts
- furniture shipped unassembled
- centrally located compartments
- 33 mm tap hole between the compartments available tabletop depths (D): 600 mm or 700 mm
- 600 mm table fitted with 400x400x250 mm compartments
- 700 mm table fitted with 400x500x250 mm compartments



Width W (mm)	Depth D=600 (mm)		Depth D=700 (mm)	
	Cat. No.	Net Price (€)	Cat. No.	Net Price (€)
1000	983956100	771	983957100	801

316

**DOUBLE-SINK UNIT WITH A SHELF
H=850 MM**

- pressed tabletop
- 40 mm flat upstand
- screw-joined table for self-assembly
- legs joined using bolts
- furniture shipped unassembled
- 33 mm tap hole between the compartments
- available tabletop depths (D): 600 mm or 700 mm
- 600 mm table fitted with 400x400x250 mm compartments
- 700 mm table fitted with 500x500x250 mm compartments, except for 983177110 with 400x500x250 mm compartments



Width W (mm)	Cat. No.	Depth D=600 (mm)	
		Net Price (€)	Width of grooved drainage R (mm)
1100	983166110	795	-
1200	983166120	818	-
1300	983166130	848	-
1400	983166140	874	320
1500	983166150	901	320
1600	983166160	931	520
1700	983166170	955	520
1800	983166180	978	720
1900	983166190	1011	720

Width W (mm)	Cat. No.	Depth D=700 (mm)	
		Net Price (€)	Width of grooved drainage R (mm)
1100	983167110	836	-
1200	983167120	862	-
1300	983167130	891	-
1400	983167140	915	-
1500	983167150	948	-
1600	983167160	976	320
1700	983167170	1011	320
1800	983167180	1034	520
1900	983167190	1067	520

NS

NS

317

**DOUBLE-SINK UNIT, HINGED DOORS
H=850 MM**

- pressed tabletop
- 40 mm flat upstand
- 33 mm tap hole between the compartments
- available tabletop depths (D): 600 mm or 700 mm
- 600 mm table fitted with 400x400x250 mm compartments
- 700 mm table fitted with 400x500x250 mm compartments
- the cabinet has no back wall
- optional lock assembly for an additional net price: 39 € per piece



Width W (mm)	Cat. No.	Depth D=600 (mm)	
		Net Price (€)	Width of grooved drainage R (mm)
1100	983176110	795	-
1200	983176120	818	-
1300	983176130	848	-
1400	983176140	874	320
1500	983176150	901	320
1600	983176160	931	520
1700	983176170	955	520
1800	983176180	978	720
1900	983176190	1011	720

Width W (mm)	Cat. No.	Depth D=700 (mm)	
		Net Price (€)	Width of grooved drainage R (mm)
1100	983177110	836	-
1200	983177120	862	-
1300	983177130	891	-
1400	983177140	915	-
1500	983177150	948	-
1600	983177160	976	320
1700	983177170	1011	320
1800	983177180	1034	520
1900	983177190	1067	520

NS

NS

396

**DOUBLE-SINK UNIT, HINGED DOORS
H=850 MM**

- pressed tabletop
- 40 mm flat upstand
- 33 mm tap hole between the compartments
- available tabletop depths (D): 600 mm or 700 mm
- 600 mm table fitted with a 400x400x250 mm compartment
- 700 mm table fitted with a 500x500x250 mm compartment, except for 983977110 with 400x500x250 mm compartments
- three wing doors in >1400 mm tables
- the cabinet has no back wall
- optional lock assembly for an additional net price: 39 € per piece



Width W (mm)	Depth D=600 (mm)		Depth D=700 (mm)	
	Cat. No.	Net Price (€)	Cat. No.	Net Price (€)
1000	983966100	1045	983967100	1092

Portfolio of Sink Units

397

DOUBLE-SINK UNIT, HINGED DOORS H=850 MM

- pressed tabletop
- 40 mm flat upstand
- 33 mm tap hole between the compartments
- available tabletop depths (D): 600 mm or 700 mm
- 600 mm table fitted with a 400x400x250 mm compartment
- 700 mm table fitted with a 500x500x250 mm compartment, except for 983987110 with 400x500x250 mm compartments
- three wing doors in >1400 mm tables the cabinet has no back wall
- optional lock assembly for an additional net price: 39 € per piece



Width W (mm)	Cat. No.	Depth D=600 (mm)	
		Net Price (€)	Width of grooved drainage R (mm)
1100	983976110	1094	-
1200	983976120	1130	-
1300	983976130	1167	-
1400	983976140	1203	320
1500	983976150	1246	320
1600	983976160	1289	520
1700	983976170	1332	520
1800	983976180	1375	720
1900	983976190	1418	720

Width W (mm)	Cat. No.	Depth D=700 (mm)	
		Net Price (€)	Width of grooved drainage R (mm)
1100	983977110	1130	-
1200	983977120	1171	-
1300	983977130	1218	-
1400	983977140	1130	-
1500	983977150	1298	-
1600	983977160	1466	320
1700	983977170	1634	320
1800	983977180	1802	520
1900	983977190	1970	520

NS

NS

398

DOUBLE-SINK UNIT, SLIDING DOORS H=850 MM

- pressed tabletop
- 40 mm flat upstand
- 33 mm tap hole between the compartments
- available tabletop depths (D): 600 mm or 700 mm
- 600 mm table fitted with 400x400x250 mm compartments
- 700 mm table fitted with 400x500x250 mm compartments
- optional lock assembly
- the cabinet has no back wall



Width W (mm)	Cat. No.	Depth D=600 (mm)	
		Net Price (€)	Width of grooved drainage R (mm)
1100	983986110	1094	-
1200	983986120	1258	-
1300	983986130	1167	-
1400	983986140	1203	320
1500	983986150	1246	320
1600	983986160	1289	520
1700	983986170	1332	520
1800	983986180	1375	720
1900	983986190	1418	720

Width W (mm)	Cat. No.	Depth D=700 (mm)	
		Net Price (€)	Width of grooved drainage R (mm)
1100	983987110	1130	-
1200	983987120	1171	-
1300	983987130	1218	-
1400	983987140	1258	-
1500	983987150	1298	-
1600	983987160	1338	320
1700	983987170	1378	320
1800	983987180	1418	520
1900	983987190	1458	520

NS

NS

399

DOUBLE-SINK UNIT, SLIDING DOORS H=850 MM

- pressed tabletop
- 40 mm flat upstand
- 33 mm tap hole between the compartments
- available tabletop depths (D): 600 mm or 700 mm
- 600 mm table fitted with 400x400x250 mm compartments
- 700 mm table fitted with 500x500x250 mm compartments, except for 984007110 with 400x500x250 mm compartments
- the cabinet has no back wall
- optional lock assembly for an additional net price: 39 € per piece



Width W (mm)	Depth D=600 (mm)		Depth D=700 (mm)	
	Cat. No.	Net Price (€)	Cat. No.	Net Price (€)
1000	983996100	1098	983997100	1156

400

**DOUBLE-SINK UNIT, SLIDING DOORS
H=850 MM**

- pressed tabletop
- 40 mm flat upstand
- 33 mm tap hole between the compartments
- available tabletop depths (D): 600 mm or 700 mm
- 600 mm table fitted with 400x400x250 mm compartments
- 700 mm table fitted with 500x500x250 mm compartments, except for 984017110 with 400x500x250 mm compartments
- the cabinet has no back wall optional lock assembly for an additional net price: 39 € per piece



Width W (mm)	Cat. No.	Depth D=600 (mm)	
		Net Price (€)	Width of grooved drainage R (mm)
1100	984006110	1132	-
1200	984006120	1161	-
1300	984006130	1194	-
1400	984006140	1224	320
1500	984006150	1255	320
1600	984006160	1288	520
1700	984006170	1320	520
1800	984006180	1354	720
1900	984006190	1386	720

NS

Width W (mm)	Cat. No.	Depth D=700 (mm)	
		Net Price (€)	Width of grooved drainage R (mm)
1100	984007110	1191	-
1200	984007120	1224	-
1300	984007130	1258	-
1400	984007140	1291	-
1500	984007150	1323	-
1600	984007160	1359	320
1700	984007170	1399	320
1800	984007180	1434	520
1900	984007190	1467	520

NS

401

**DOUBLE-SINK UNIT WITH A CABINET AND A SHELF
H=850 MM**

- pressed tabletop
- 40 mm flat upstand
- adjustable shelf inside the cabinet
- 33 mm tap hole between the compartments
- 600 mm table fitted with 400x400x250 mm compartments
- 700 mm table fitted with 500x500x250 mm compartments, except for 9810927140 and 9810927150 with 400x500x250 mm compartments
- waste shredder hole can be cut for additional payment (please specify the compartment)
- optional lock assembly for an additional net price: 39 € per piece



Width W (mm)	Cat. No.	Depth D=600 (mm)	
		Net Price (€)	Width of grooved drainage R (mm)
1100	984016110	1132	-
1200	984016120	1161	-
1300	984016130	1194	-
1400	984016140	1224	320
1500	984016150	1255	320
1600	984016160	1288	520
1700	984016170	1320	520
1800	984016180	1354	720
1900	984016190	1386	720

NS

Width W (mm)	Cat. No.	Depth D=700 (mm)	
		Net Price (€)	Width of grooved drainage R (mm)
1100	984017110	1191	-
1200	984017120	1224	-
1300	984017130	1258	-
1400	984017140	1291	-
1500	984017150	1323	-
1600	984017160	1359	320
1700	984017170	1399	320
1800	984017180	1434	520
1900	984017190	1467	520

NS

1092

**DOUBLE-SINK UNIT WITH A CABINET AND A SHELF
H=850 MM**

- pressed tabletop
- 40 mm flat upstand
- adjustable shelf inside the cabinet
- 33 mm tap hole between the compartments
- 600 mm table fitted with 400x400x250 mm compartments
- 700 mm table fitted with 500x500x250 mm compartments, except for 9810927140 and 9810937150 with 400x500x250 mm compartments
- waste shredder hole can be cut for an additional net price: 32 € (please specify the compartment)
- optional lock assembly for an additional net price: 39 € per piece

NEW

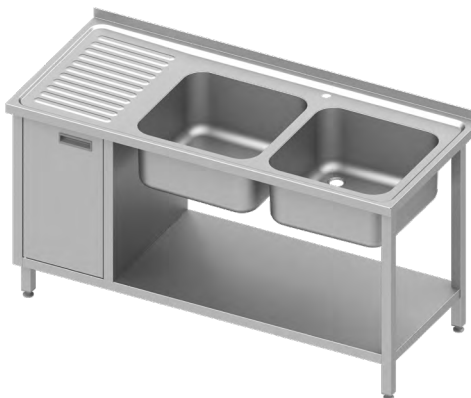

Width W (mm)	Cat. No.	Depth D=600 (mm)	
		Net Price (€)	Width of grooved drainage R (mm)
1400	9810926140	1195	320
1500	9810926150	1223	320
1600	9810926160	1248	520
1700	9810926170	1276	520
1800	9810926180	1300	720
1900	9810926190	1331	720

Width W (mm)	Cat. No.	Depth D=700 (mm)	
		Net Price (€)	Width of grooved drainage R (mm)
1400	9810927140	1253	-
1500	9810927150	1281	-
1600	9810927160	1315	320
1700	9810927170	1344	320
1800	9810927180	1374	520
1900	9810927190	1401	520

1093

**DOUBLE-SINK UNIT WITH A BLOCK OF TWO DRAWERS AND A SHELF
H=850 MM**

- pressed tabletop
- 40 mm flat upstand
- 200 mm deep drawers
- 33 mm tap hole between the compartments
- 600 mm table fitted with 400x400x250 mm compartments
- 700 mm table fitted with 500x500x250 mm compartments, except for 9810767140 and 9810767150 with 400x500x250 mm compartments
- waste shredder hole can be cut for an additional net price: 32 € (please specify the compartment)
- optional lock assembly for an additional net price: 39 € per piece



NEW

Width W (mm)	Cat. No.	Depth D=600 (mm)	
		Net Price (€)	Width of grooved drainage R (mm)
1400	9810936140	1195	320
1500	9810936150	1223	320
1600	9810936160	1248	520
1700	9810936170	1276	520
1800	9810936180	1300	720
1900	9810936190	1331	720

Width W (mm)	Cat. No.	Depth D=700 (mm)	
		Net Price (€)	Width of grooved drainage R (mm)
1400	9810937140	1253	-
1500	9810937150	1281	-
1600	9810937160	1315	320
1700	9810937170	1344	320
1800	9810937180	1374	520
1900	9810937190	1401	520

1076

**DOUBLE-SINK UNIT WITH A BLOCK OF TWO DRAWERS AND A SHELF
H=850 MM**

- pressed tabletop
- 40 mm flat upstand
- 200 mm deep drawers
- 33 mm tap hole between the compartments
- 600 mm table fitted with 400x400x250 mm compartments
- 700 mm table fitted with 500x500x250 mm compartments, except for 9810777140 and 9810777150 with 400x500x250 mm compartments
- waste shredder hole can be cut for an additional net price: 32 € (please specify the compartment)
- optional lock assembly for an additional net price: 39 € per piece



NEW

Width W (mm)	Cat. No.	Depth D=600 (mm)	
		Net Price (€)	Width of grooved drainage R (mm)
1400	9810766140	1163	320
1500	9810766150	1187	320
1600	9810766160	1210	520
1700	9810766170	1236	520
1800	9810766180	1255	720
1900	9810766190	1278	720

Width W (mm)	Cat. No.	Depth D=700 (mm)	
		Net Price (€)	Width of grooved drainage R (mm)
1400	9810767140	1225	-
1500	9810767150	1253	-
1600	9810767160	1278	320
1700	9810767170	1310	320
1800	9810767180	1333	520
1900	9810767190	1359	520

1077

**DOUBLE-SINK UNIT WITH A BLOCK OF TWO DRAWERS AND A SHELF
H=850 MM**

- pressed tabletop
- 40 mm flat upstand
- 150 mm deep drawers
- 33 mm tap hole between the compartments
- 600 mm table fitted with 400x400x250 mm compartments
- 700 mm table fitted with 500x500x250 mm compartments, except for 9810787140 and 9810787150 with 400x500x250 mm compartments
- waste shredder hole can be cut for an additional net price: 32 € (please specify the compartment)
- optional lock assembly for an additional net price: 39 € per piece



NEW

Width W (mm)	Cat. No.	Depth D=600 (mm)	
		Net Price (€)	Width of grooved drainage R (mm)
1400	9810776140	1163	320
1500	9810776150	1187	320
1600	9810776160	1210	520
1700	9810776170	1236	520
1800	9810776180	1255	720
1900	9810776190	1278	720

Width W (mm)	Cat. No.	Depth D=700 (mm)	
		Net Price (€)	Width of grooved drainage R (mm)
1400	9810777140	1225	-
1500	9810777150	1253	-
1600	9810777160	1278	320
1700	9810777170	1310	320
1800	9810777180	1333	520
1900	9810777190	1359	520

1078

**DOUBLE-SINK UNIT WITH A BLOCK OF THREE DRAWERS AND A SHELF
H=850 MM**

- pressed tabletop
- 40 mm flat upstand
- 150 mm deep drawers
- 33 mm tap hole between the compartments
- 600 mm table fitted with 400x400x250 mm compartments
- 700 mm table fitted with 500x500x250 mm compartments, except for 9810797140 and 9810797150 with 400x500x250 mm compartments
- waste shredder hole can be cut for an additional net price: 32 € (please specify the compartment)
- optional lock assembly for an additional net price: 39 € per piece



NEW

Width W (mm)	Cat. No.	Depth D=600 (mm)	
		Net Price (€)	Width of grooved drainage R (mm)
1400	9810786140	1300	320
1500	9810786150	1323	320
1600	9810786160	1350	520
1700	9810786170	1376	520
1800	9810786180	1399	720
1900	9810786190	1418	720

Width W (mm)	Cat. No.	Depth D=700 (mm)	
		Net Price (€)	Width of grooved drainage R (mm)
1400	9810787140	1376	-
1500	9810787150	1406	-
1600	9810787160	1434	320
1700	9810787170	1458	320
1800	9810787180	1484	520
1900	9810787190	1509	520

1079

**DOUBLE-SINK UNITS WITH SPACE FOR A REFRIGERATOR OR A DISHWASHER
H=850 MM**

- pressed tabletop
- 40 mm flat upstand
- screw-joined table for self-assembly
- legs joined using bolts
- furniture shipped unassembled
- 33 mm tap hole in the middle of the compartment
- 600 mm table fitted with a 400x400x250 mm compartment
- 700 mm table fitted with a 500x500x250 mm compartment, except for 9810627120 with a 400x500x250 mm compartment
- waste shredder hole can be cut for an additional net price: 32 €



NEW

Width W (mm)	Cat. No.	Depth D=600 (mm)	
		Net Price (€)	Width of grooved drainage R (mm)
1400	9810796140	1300	320
1500	9810796150	1323	320
1600	9810796160	1350	520
1700	9810796170	1376	520
1800	9810796180	1399	720
1900	9810796190	1418	720

Width W (mm)	Cat. No.	Depth D=700 (mm)	
		Net Price (€)	Width of grooved drainage R (mm)
1400	9810797140	1376	-
1500	9810797150	1406	-
1600	9810797160	1434	320
1700	9810797170	1458	320
1800	9810797180	1484	520
1900	9810797190	1509	520

1062

**DOUBLE-SINK UNITS WITH SPACE FOR A REFRIGERATOR OR A DISHWASHER
H=900 MM**

- pressed tabletop
- 40 mm flat upstand
- screw-joined table for self-assembly
- legs joined using bolts
- furniture shipped unassembled
- 33 mm tap hole in the middle of the compartment
- 600 mm table fitted with a 400x400x250 mm compartment
- 700 mm table fitted with a 500x500x250 mm compartment, except for 9810637120 with a 400x500x250 mm compartment
- waste shredder hole can be cut for an additional net price: 32 €



NEW

Width W (mm)	Cat. No.	Depth D=600 (mm)	
		Net Price (€)	Width of grooved drainage R (mm)
1600	9810626160	769	520
1700	9810626170	790	520
1800	9810626180	808	720
1900	9810626190	828	720

Width W (mm)	Cat. No.	Depth D=700 (mm)	
		Net Price (€)	Width of grooved drainage R (mm)
1600	9810627160	803	320
1700	9810627170	823	320
1800	9810627180	846	520
1900	9810627190	865	520

1063

**DOUBLE-SINK UNITS WITH SPACE FOR A REFRIGERATOR OR A DISHWASHER
H=900 MM**

- pressed tabletop
- 40 mm flat upstand
- screw-joined table for self-assembly
- legs joined using bolts
- furniture shipped unassembled
- 33 mm tap hole in the middle of the compartment
- 600 mm table fitted with a 400x400x250 mm compartment
- 700 mm table fitted with a 500x500x250 mm compartment, except for 9810637120 with a 400x500x250 mm compartment
- waste shredder hole can be cut for an additional net price: 32 €

NEW



Width W (mm)	Cat. No.	Depth D=600 (mm)	
		Net Price (€)	Width of grooved drainage R (mm)
1600	9810636160	769	520
1700	9810636170	790	520
1800	9810636180	808	720
1900	9810636190	828	720

Width W (mm)	Cat. No.	Depth D=700 (mm)	
		Net Price (€)	Width of grooved drainage R (mm)
1600	9810637160	803	320
1700	9810637170	823	320
1800	9810637180	846	520
1900	9810637190	865	520



See also:
AQUA dishwashing machines



SINGLE-SINK UNIT

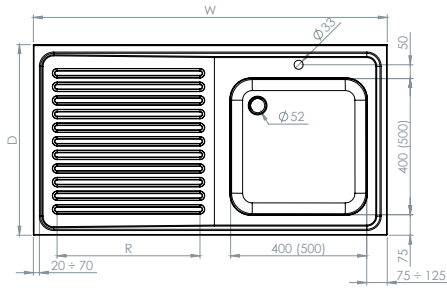

Top view

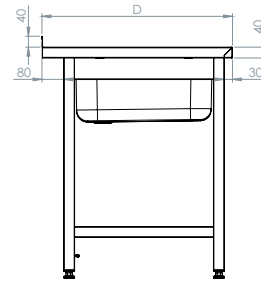

Side view

DOUBLE-SINK UNIT

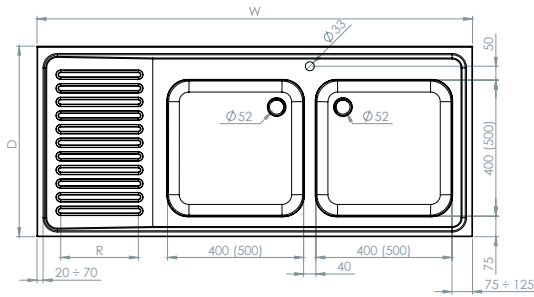

Top view

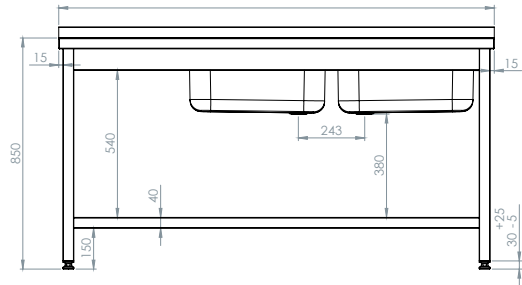

Front view

SINK UNIT WITH HINGED DOOR CABINET

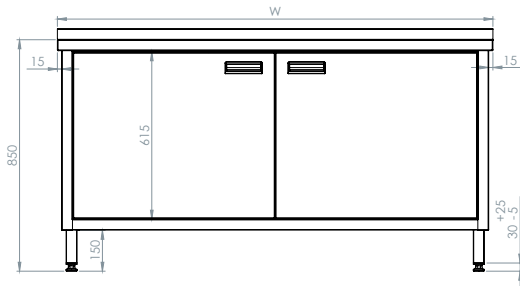

Front view

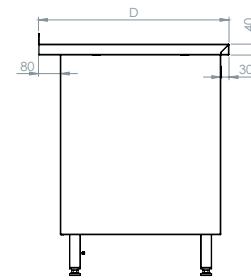

Side view

SINK UNIT WITH SLIDING DOOR CABINET

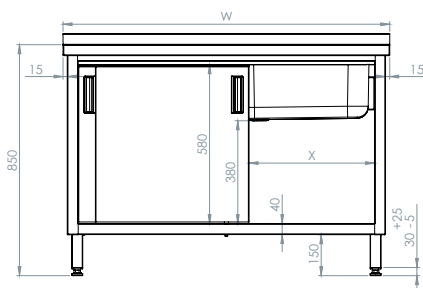

Front view

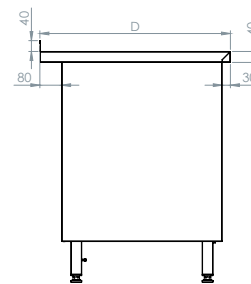

Side view

Portfolio of Sink Units

SINK UNIT WITH A BLOCK OF DRAWERS

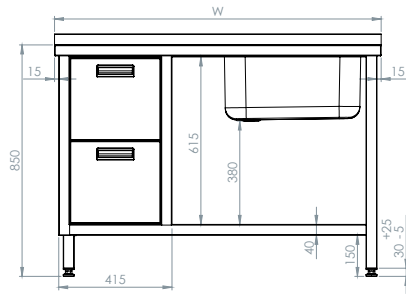

Front view

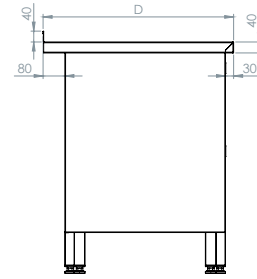

Side view

SINK UNIT WITH A CABINET AND A SHELF

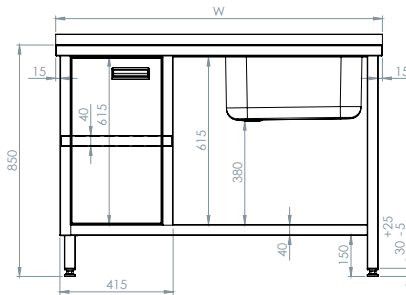

Front view

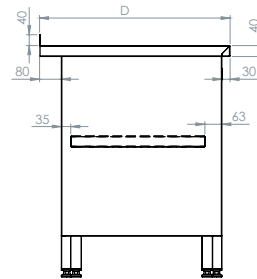

Side view

SINK UNIT WITH SPACE FOR A REFRIGERATOR OR A DISHWASHER

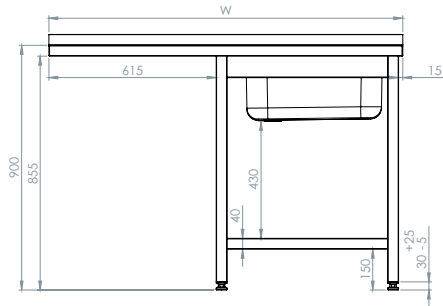

Front view

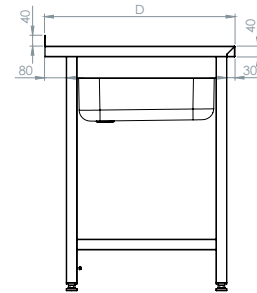

Side view

Chef's Tables

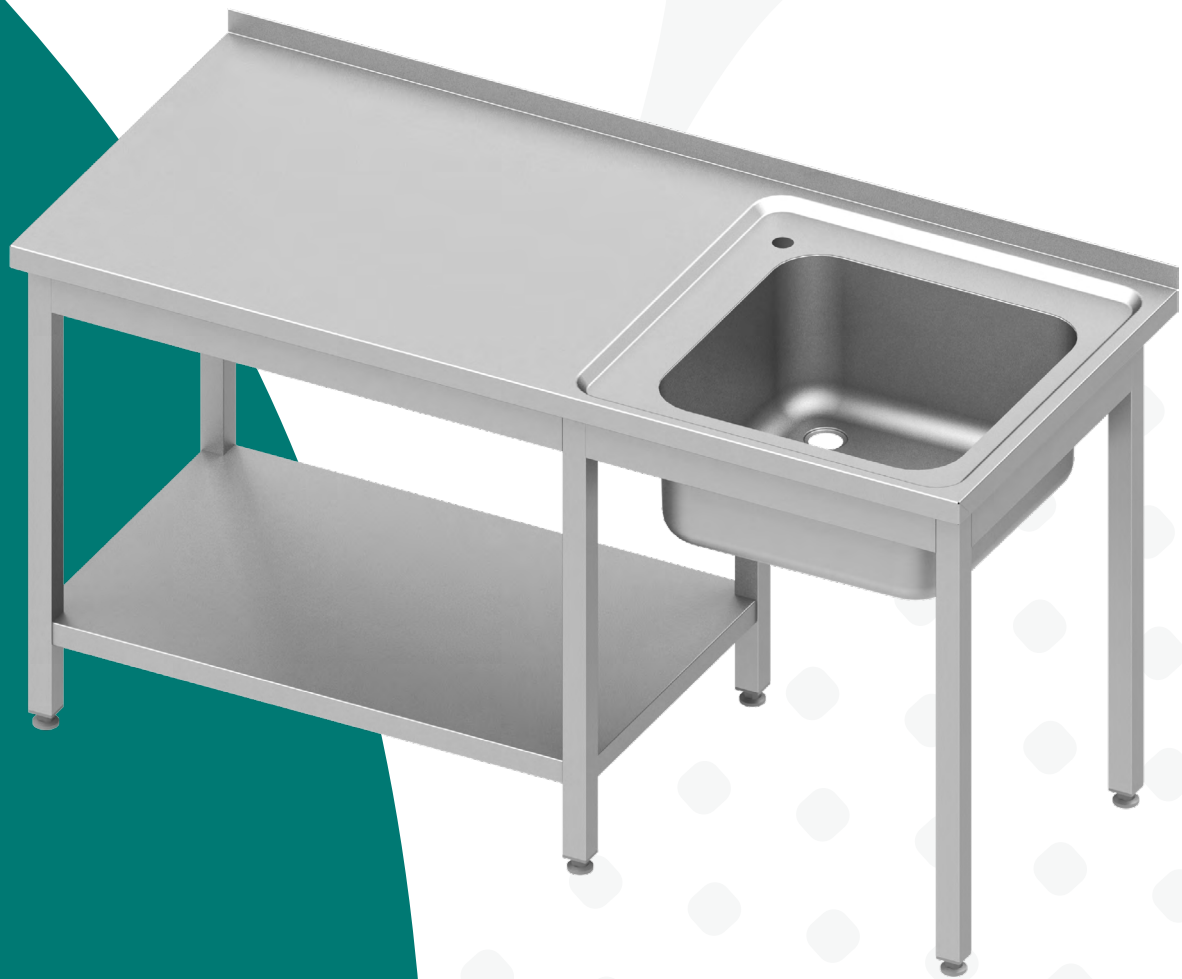

NEW



Portfolio of Sink Units

Discover Benefits and Uses of Chef's Tables

Pressed recess around the sink compartment to keep it clean



Tabletop and sink compartments made of **AISI 304 steel** with high resistance to corrosive agents



Space for a **waste basket** to increase ergonomics at work

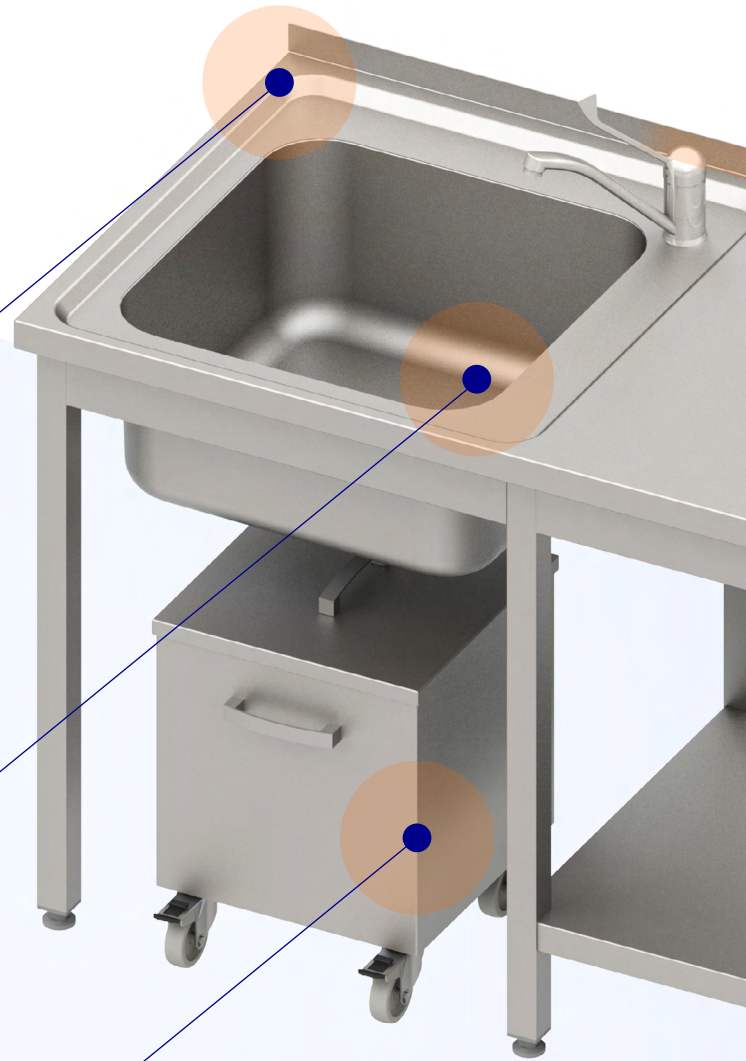

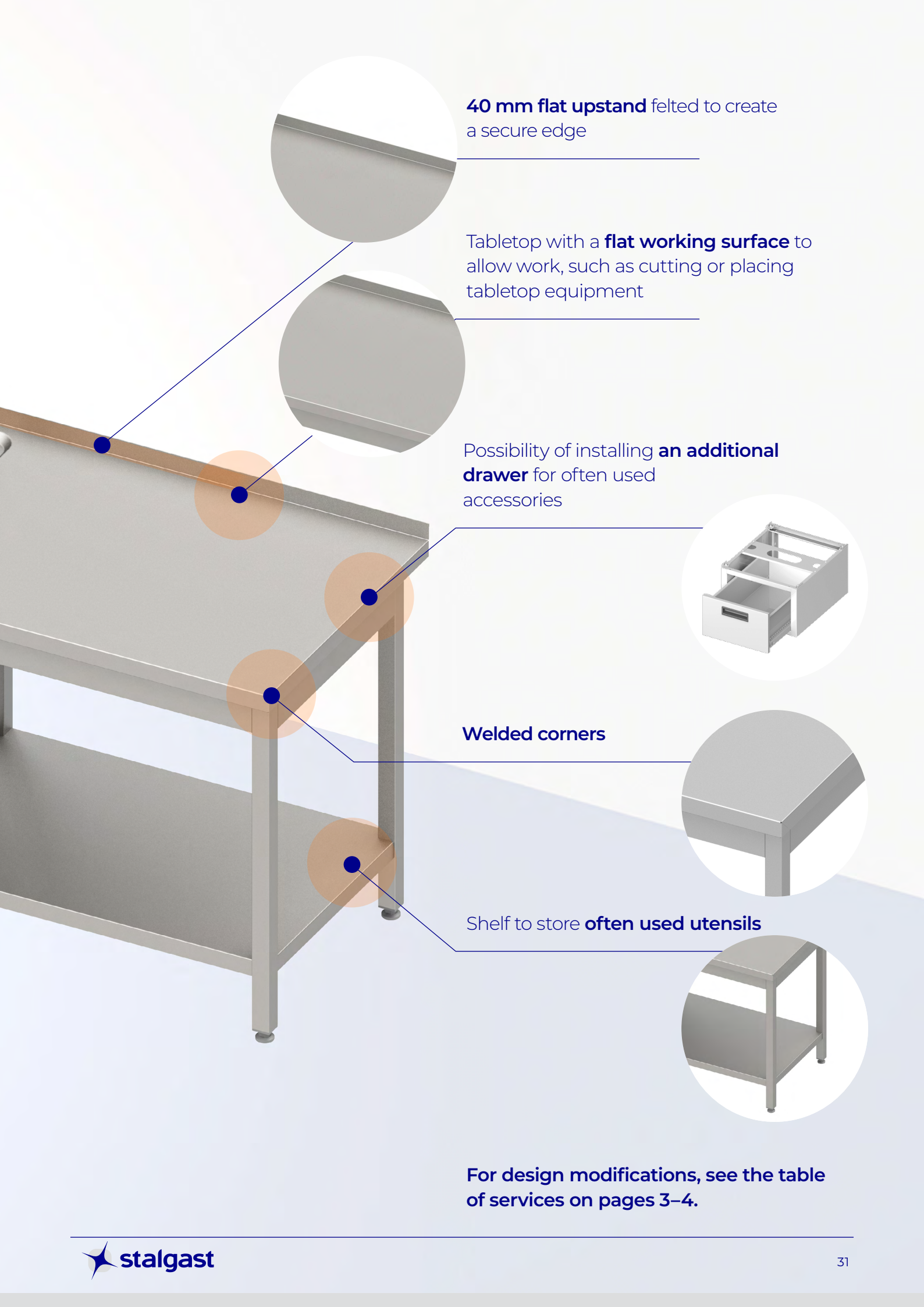

40 mm flat upstand felted to create a secure edge

Tabletop with a **flat working surface** to allow work, such as cutting or placing tabletop equipment

Possibility of installing **an additional drawer** for often used accessories

Welded corners

Shelf to store **often used utensils**

For design modifications, see the table of services on pages 3–4.

Portfolio of Sink Units

1094

SINGLE-SINK CHEF'S TABLE WITH A SHELF H=850 MM

- flat top with pressed recess around the sink compartment
- 40 mm flat upstand
- 33 mm tap hole
- 600 mm table fitted with a 400x400x250 mm compartment
- 700 mm table fitted with a 500x500x250 mm compartment

NEW



Width W (mm)	Depth D=600 (mm)		Depth D=700 (mm)	
	Cat. No.	Net Price (€)	Cat. No.	Net Price (€)
1200	9810946120	677	9810947120	765
1300	9810946130	703	9810947130	793
1400	9810946140	729	9810947140	821
1500	9810946150	755	9810947150	849
1600	9810946160	781	9810947160	877
1700	9810946170	807	9810947170	905
1800	9810946180	833	9810947180	933

HANGING DRAWER H=260 MM

- for >600 mm wide tables
- 982324041 for 600 mm deep tables
- 982325041 for 700 mm deep tables



Width W (mm)	Depth D=480 (mm)		Depth D=580 (mm)	
	Cat. No.	Net Price (€)	Cat. No.	Net Price (€)
410	982324041	151	982325041	158

1095

SINGLE-SINK CHEF'S TABLE WITH A SHELF H=850 MM

- flat top with pressed recess around the sink compartment
- 40 mm flat upstand
- 33 mm tap hole
- 600 mm table fitted with a 400x400x250 mm compartment
- 700 mm table fitted with a 500x500x250 mm compartment

NEW



Width W (mm)	Depth D=600 (mm)		Depth D=700 (mm)	
	Cat. No.	Net Price (€)	Cat. No.	Net Price (€)
1200	9810956120	677	9810957120	765
1300	9810956130	703	9810957130	793
1400	9810956140	729	9810957140	821
1500	9810956150	755	9810957150	849
1600	9810956160	781	9810957160	877
1700	9810956170	807	9810957170	905
1800	9810956180	833	9810957180	933

HANGING DRAWER H=260 MM

- for >600 mm wide tables
- 982324041 for 600 mm deep tables
- 982325041 for 700 mm deep tables



Width W (mm)	Depth D=480 (mm)		Depth D=580 (mm)	
	Cat. No.	Net Price (€)	Cat. No.	Net Price (€)
410	982324041	151	982325041	158

1096

DOUBLE-SINK CHEF'S TABLE WITH A SHELF H=850 MM

- flat tabletop with pressed recess around sink compartments
- 40 mm flat upstand
- 33 mm tap hole between the compartments
- 600 mm table fitted with 400x400x250 mm compartments
- 700 mm table fitted with 500x500x250 mm compartments

NEW



Width W (mm)	Depth D=600 (mm)	
	Cat. No.	Net Price (€)
1800	9810966180	973
1900	9810966190	1000
2000	9810966200	1027
2100	9810966210	1054
2200	9810966220	1081
2300	9810966230	1108
2400	9810966240	1135
2500	9810966250	1162
2600	9810966260	1189

Width W (mm)	Depth D=700 (mm)	
	Cat. No.	Net Price (€)
1800	9810967180	1107
1900	9810967190	1142
2000	9810967200	1177
2100	9810967210	1212
2200	9810967220	1247
2300	9810967230	1282
2400	9810967240	1317
2500	9810967250	1352
2600	9810967260	1387

HANGING DRAWER H=260 MM

- for >600 mm wide tables
- 982324041 for 600 mm deep tables
- 982325041 for 700 mm deep tables



Width W (mm)	Depth D=480 (mm)		Depth D=580 (mm)	
	Cat. No.	Net Price (€)	Cat. No.	Net Price (€)
410	982324041	151	982325041	158

1097

**DOUBLE-SINK CHEF'S TABLE WITH A SHELF
H=850 MM**

- flat tabletop with pressed recess around sink compartments
- 40 mm flat upstand
- 33 mm tap hole between the compartments
- 600 mm table fitted with 400x400x250 mm compartments
- 700 mm table fitted with 500x500x250 mm compartments

NEW



Depth D=600 (mm)		
Width W (mm)	Cat. No.	Net Price (€)
1800	9810976180	973
1900	9810976190	1000
2000	9810976200	1027
2100	9810976210	1054
2200	9810976220	1081
2300	9810976230	1108
2400	9810976240	1135
2500	9810976250	1162
2600	9810976260	1189

Depth D=700 (mm)		
Width W (mm)	Cat. No.	Net Price (€)
1800	9810977180	1107
1900	9810977190	1142
2000	9810977200	1177
2100	9810977210	1212
2200	9810977220	1247
2300	9810977230	1282
2400	9810977240	1317
2500	9810977250	1352
2600	9810977260	1387

**HANGING DRAWER
H=260 MM**

- for >600 mm wide tables
- 982324041 for 600 mm deep tables
- 982325041 for 700 mm deep tables



Width W (mm)	Depth D=480 (mm)		Depth D=580 (mm)	
	Cat. No.	Net Price (€)	Cat. No.	Net Price (€)
410	982324041	151	982325041	158



See also:
Sink and washbasin taps



Portfolio of Sink Units

SINGLE-SINK CHEF'S TABLE WITH A SHELF

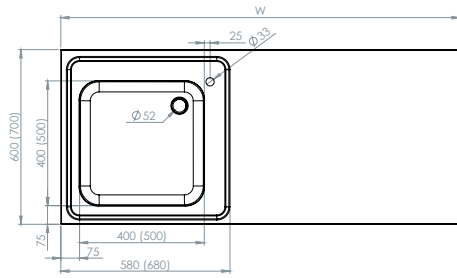

Top view

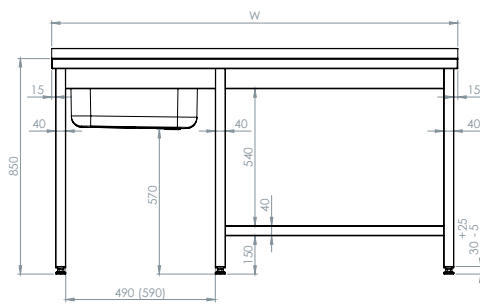

Front view

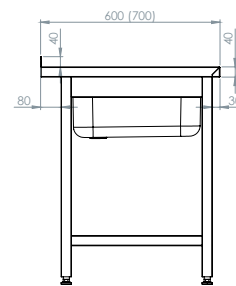

Side view

DOUBLE-SINK CHEF'S TABLE WITH A SHELF

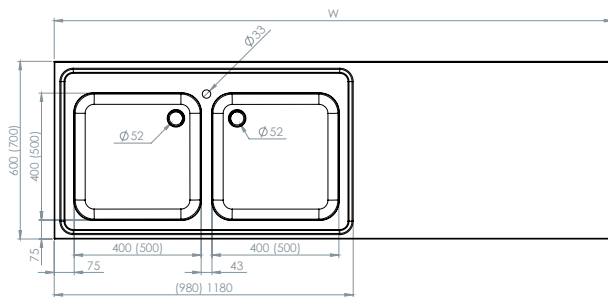

Top view

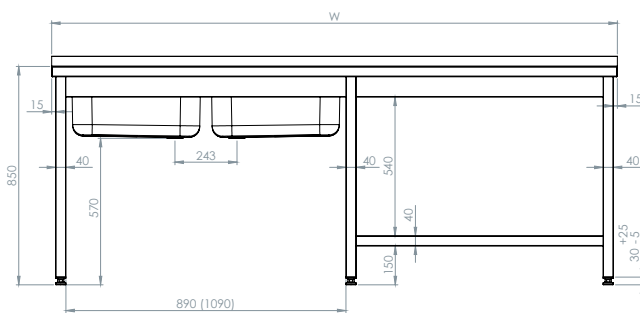

Front view

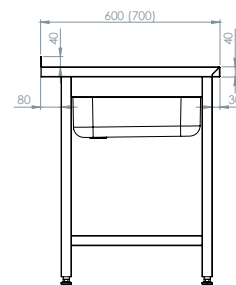

Side view



Contact us



Stalgast sp. z o. o.
03-736, Plac Konesera 9
Warsaw, Poland



stalcast.eu
E-mail:
export@stalcast.com

BLATOPEN_2024_04_16

